

A-A 断面 1/50

軒入れ (R) 屋根交通 1/10

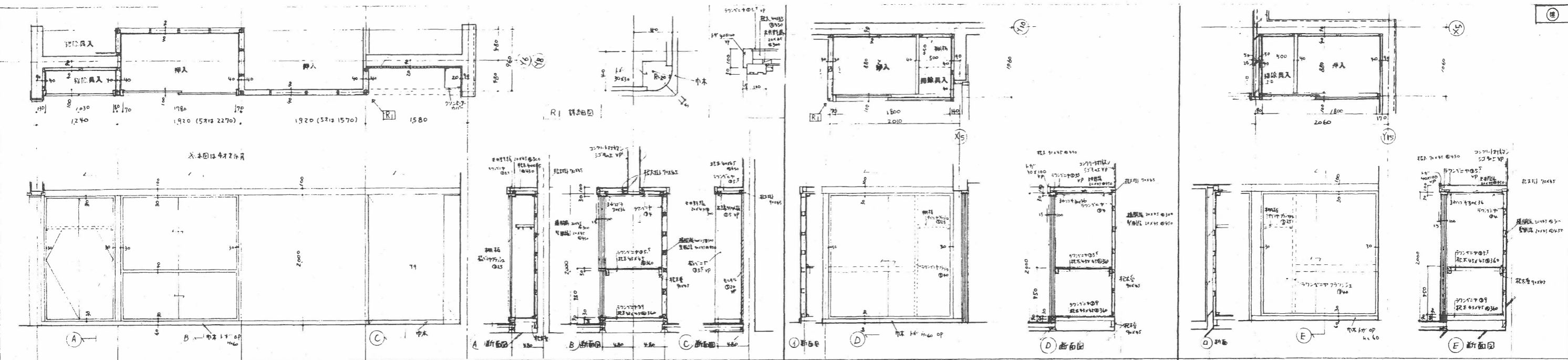

3才 4才 5才 保育室 押入 押除具入 1:30 2才 保育室 押入 押除具入 1:30 1才 保育室 押入 押除具入 1:30

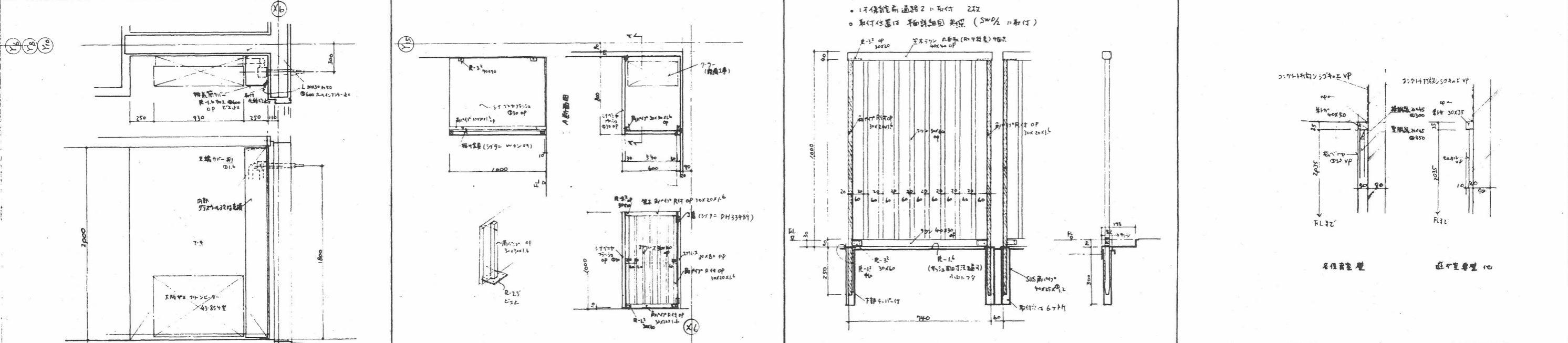

2才 3才 4才 5才 押入 押除具入 1:20 1才 7-5-カード 1:20 1才 危険防止柵 1:10 保育室壁詳細図 1:10

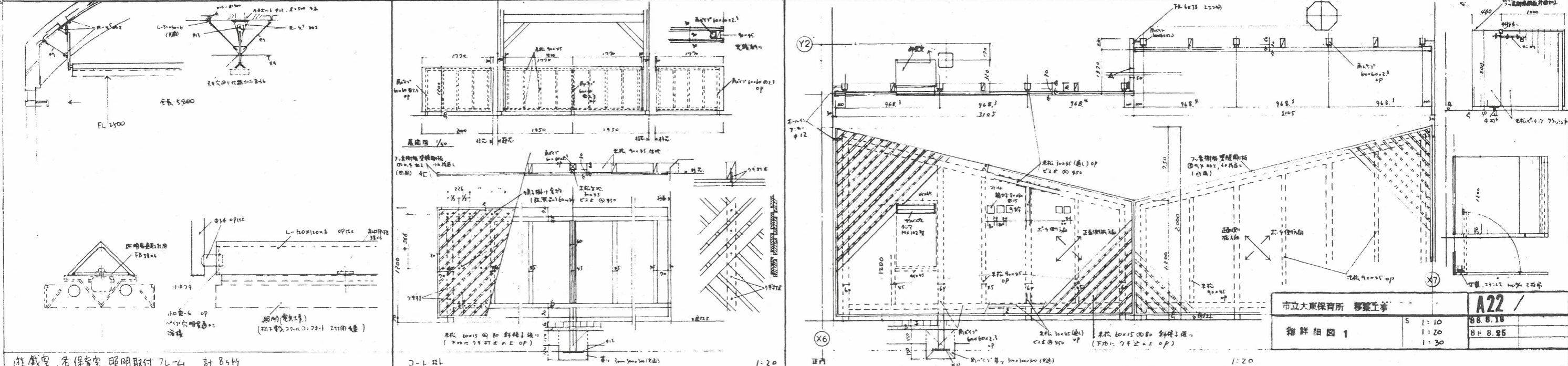

遊戯室、若保育室 照明取付 7L-4 計 84軒 1:20 市立大東保育所 移築工事 A22 / 5 1:10 88.8.18 1:20 84.8.25 1:30

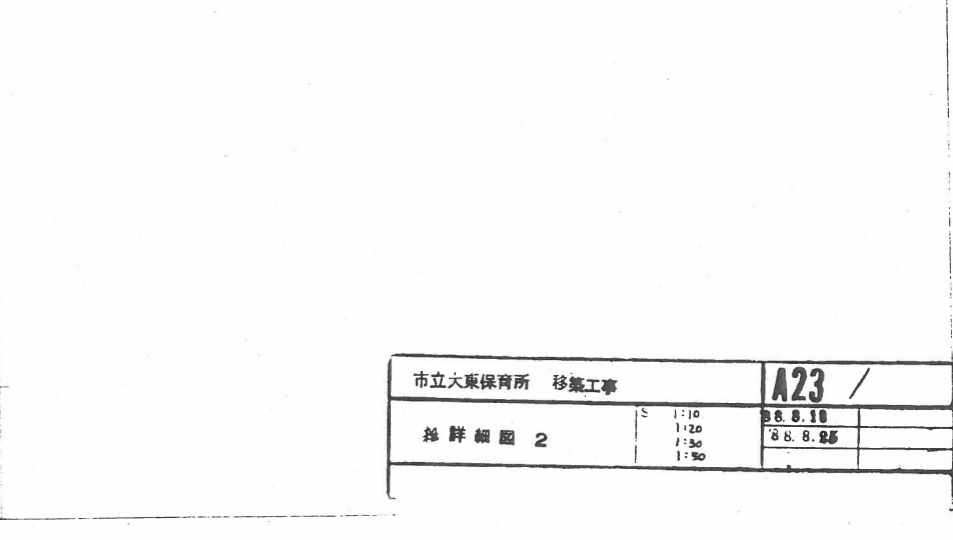
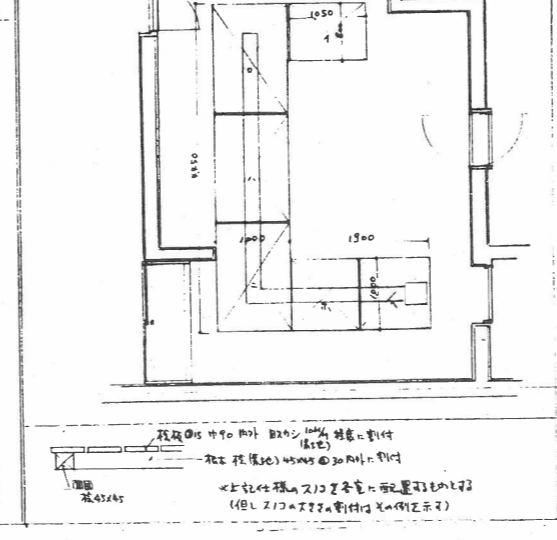
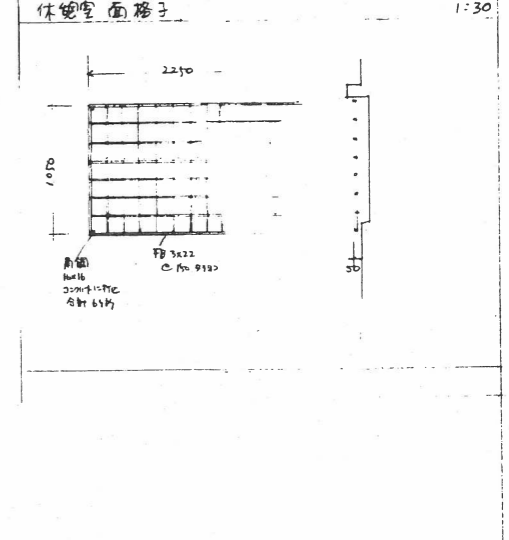
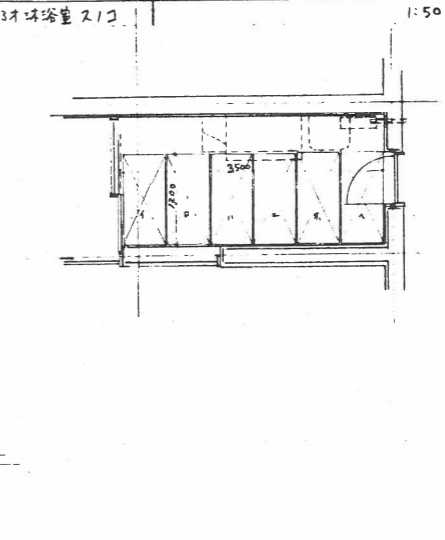
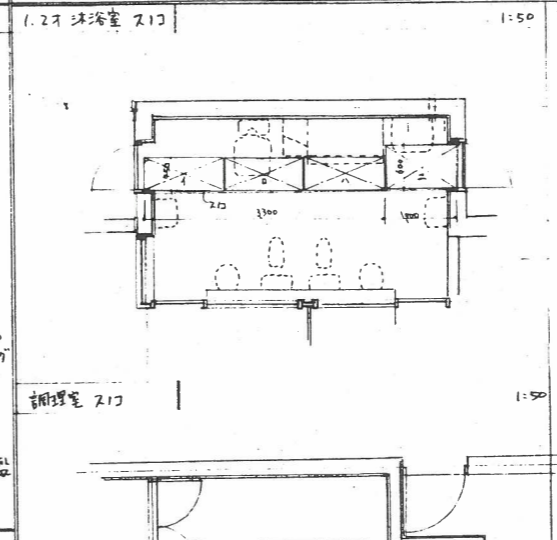
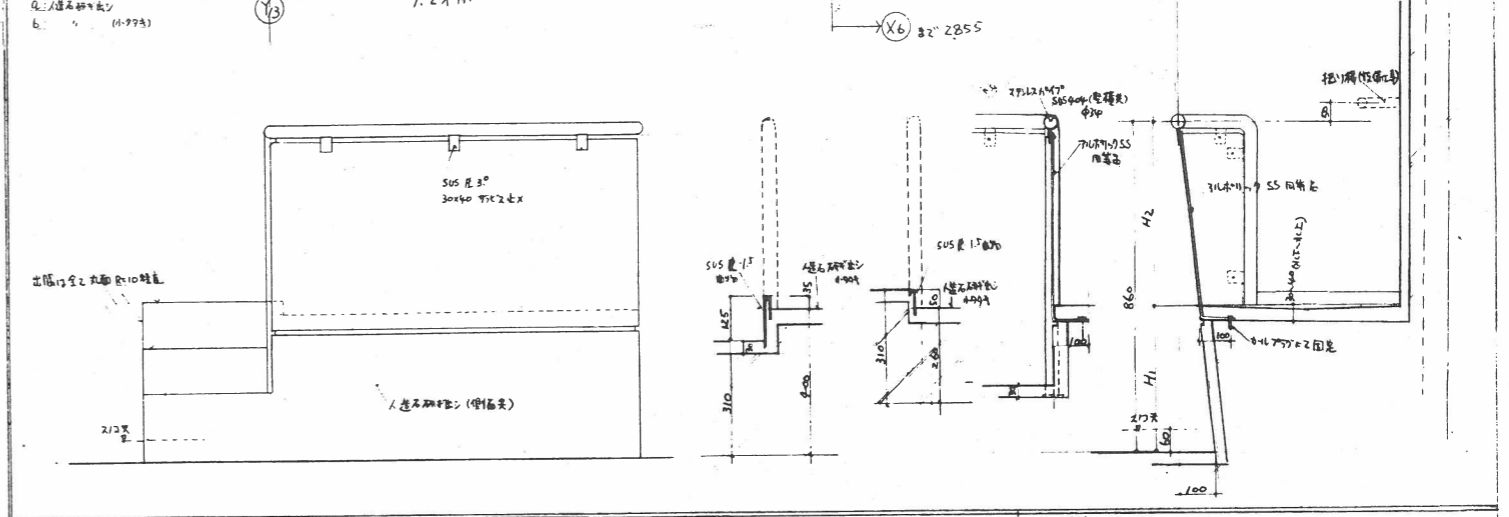
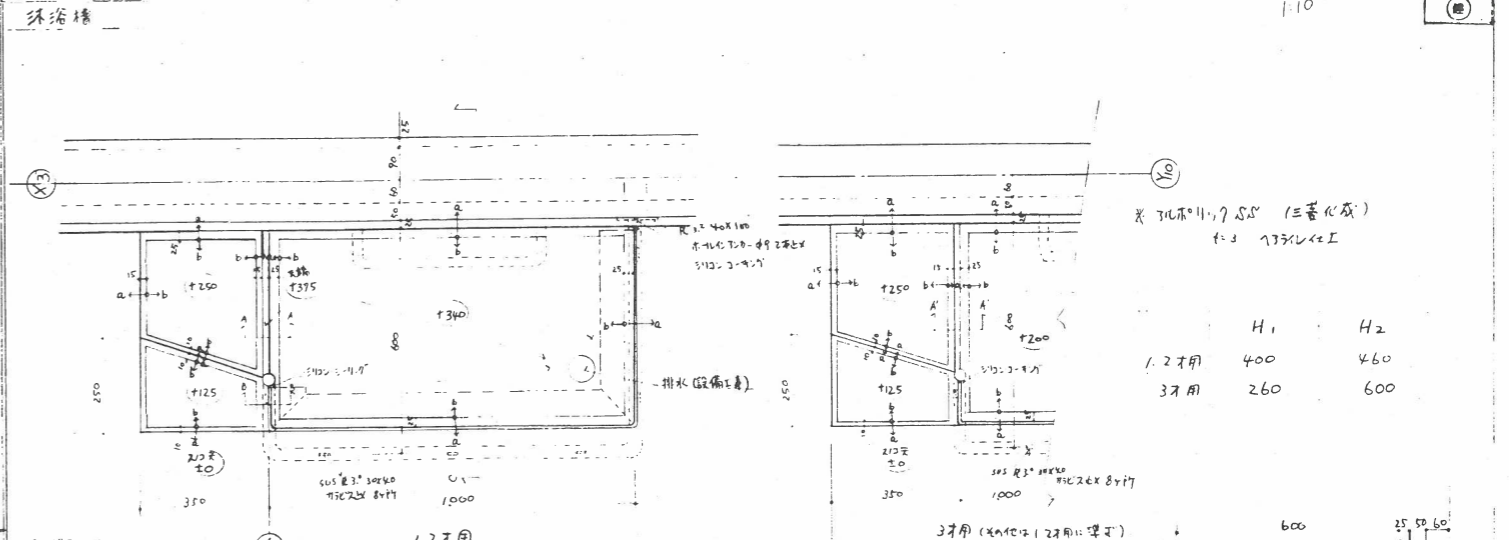
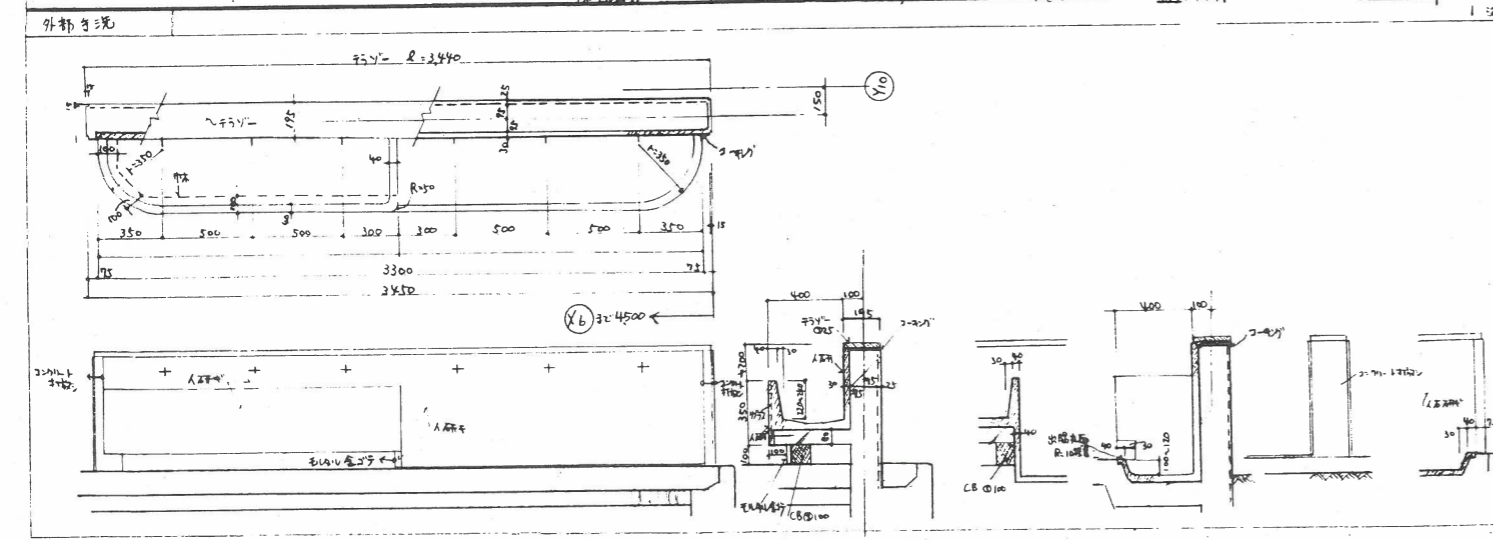
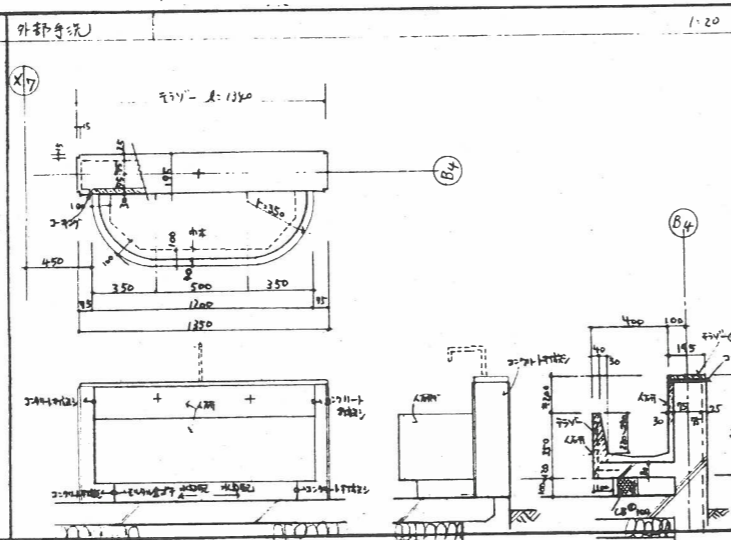
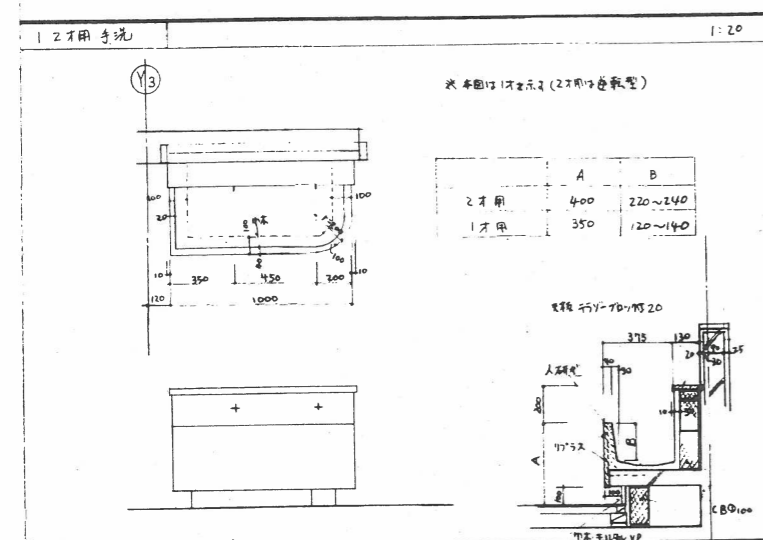
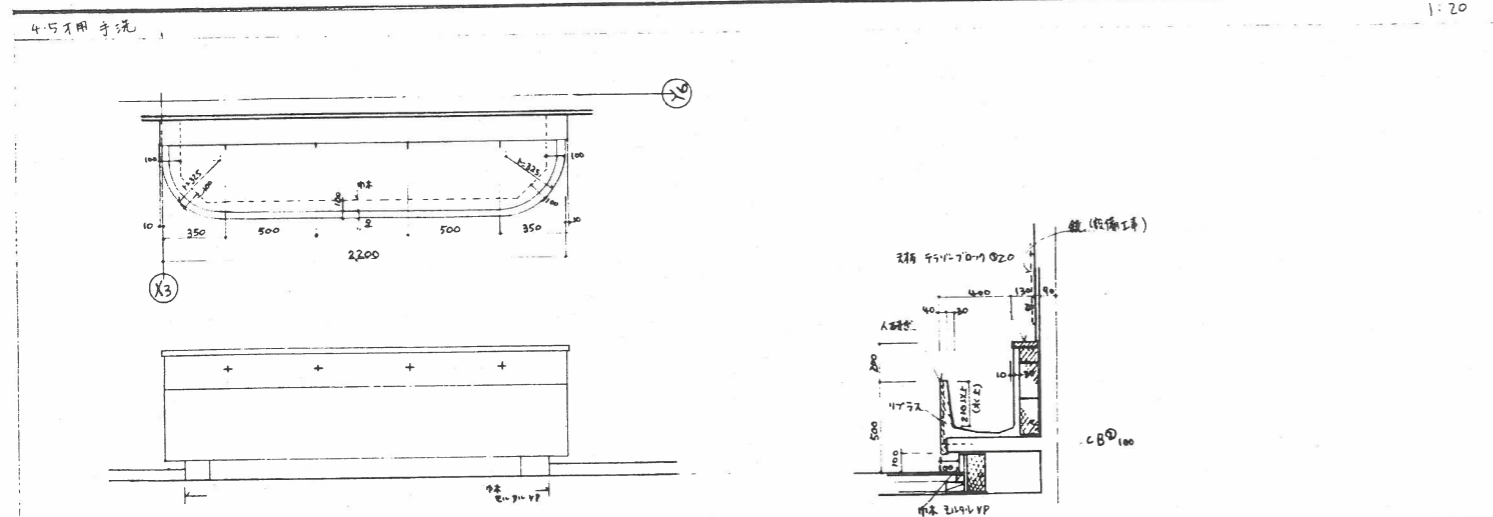
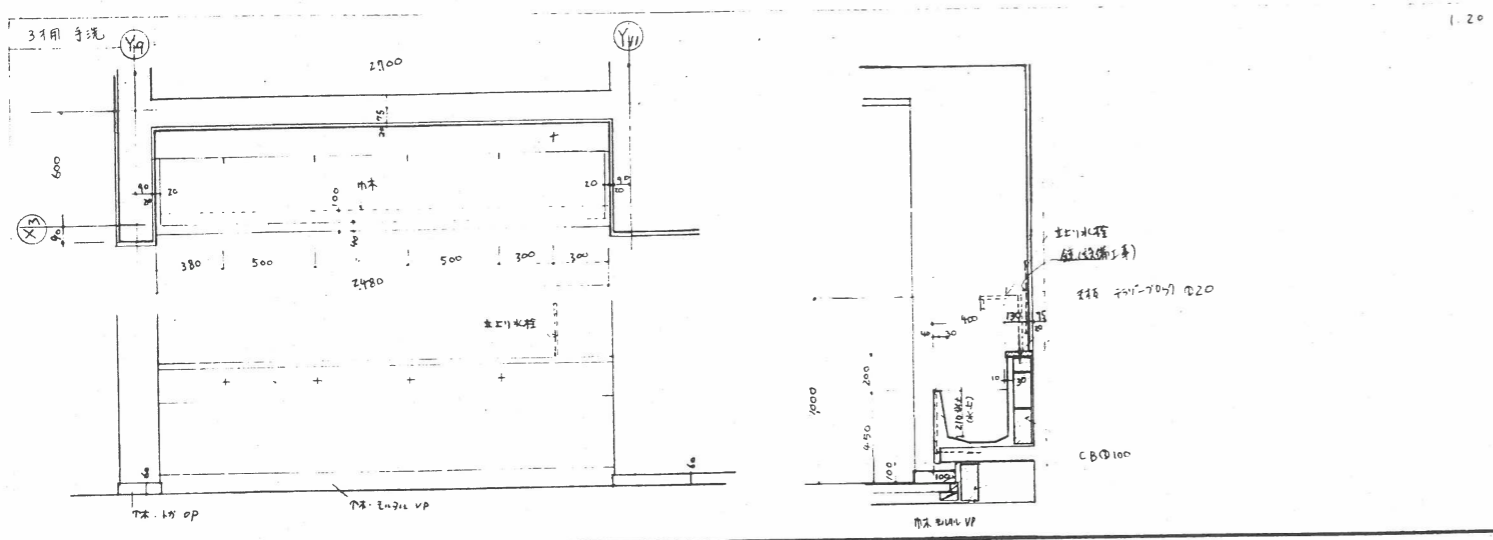

市立大東保育所 移築工事	A23 /
詳細図 2	3.8.18
	3.8.25
	1:10
	1:20
	1:30
	1:50

